













# korbo

## EDU TECHNIX

420 PIECES : 4+ YEARS OLD

100 ways to spin, learn & play!

A		120x
B		90x
C		50x
D		50x
E		22x
F		20x
H		8x
I		8x
J		8x
K		8x
L		26x
N		10x

## Various Korbo connections



REMI  
04-445 Warszawa, Poland  
ul. Szafarzy 71  
tel. +48 22 858 16 55  
www.korbo.eu

PL Kolorystyka wszystkich konstrukcji jest przykładowa.  
GB Colour combinations of all constructions is only an example.  
DE Die abgebildeten Farbkombinationen der Figuren sind nur Beispiele.  
RU Расцветка всех конструкций случайная.  
NL De kleurencombinaties van alle constructies zijn bij wijze van voorbeeld.  
ES Los colores de todas las construcciones sirven de ejemplo.  
FR Les couleurs de toutes les constructions ce n'est qu'un exemple.

2 4 5 2 2 4 6 6 2 3 1 2

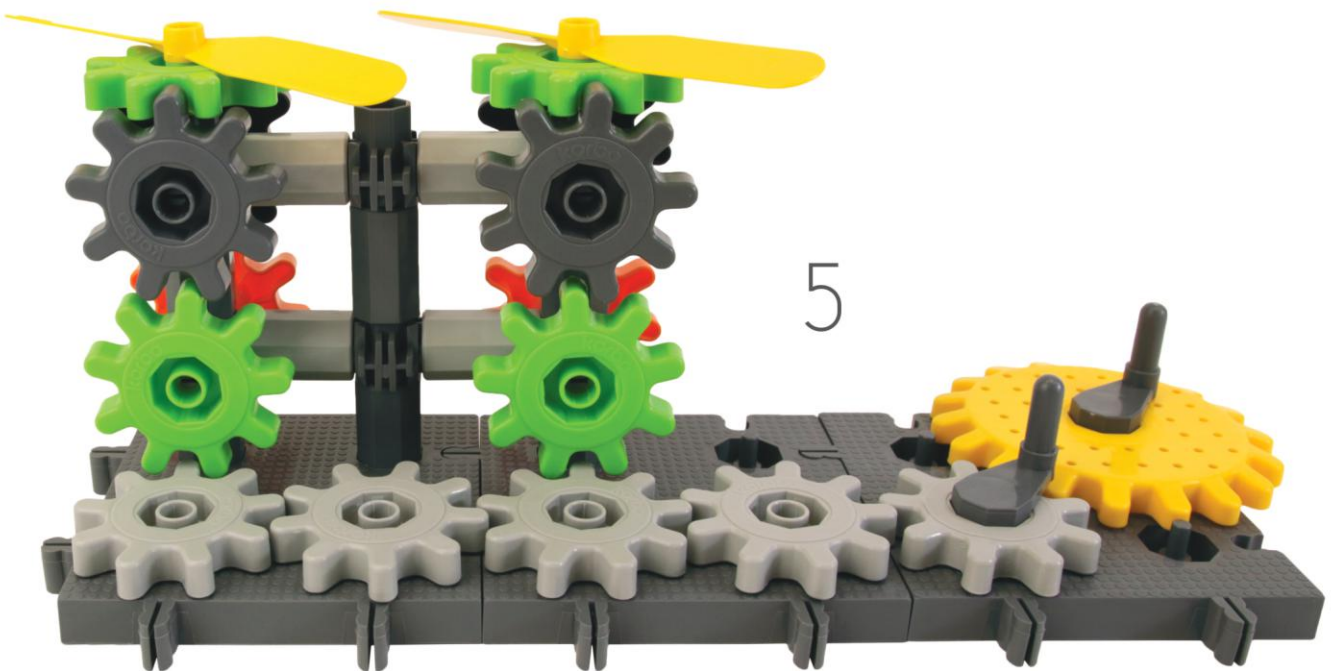
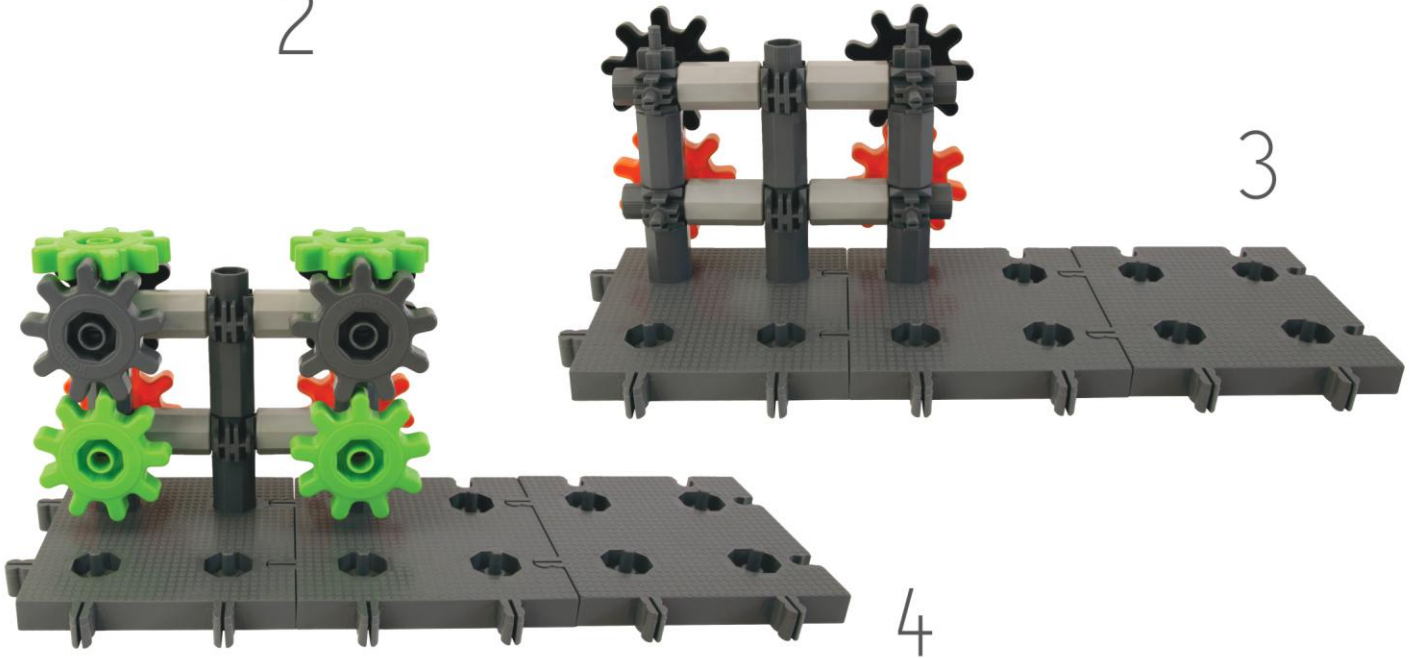
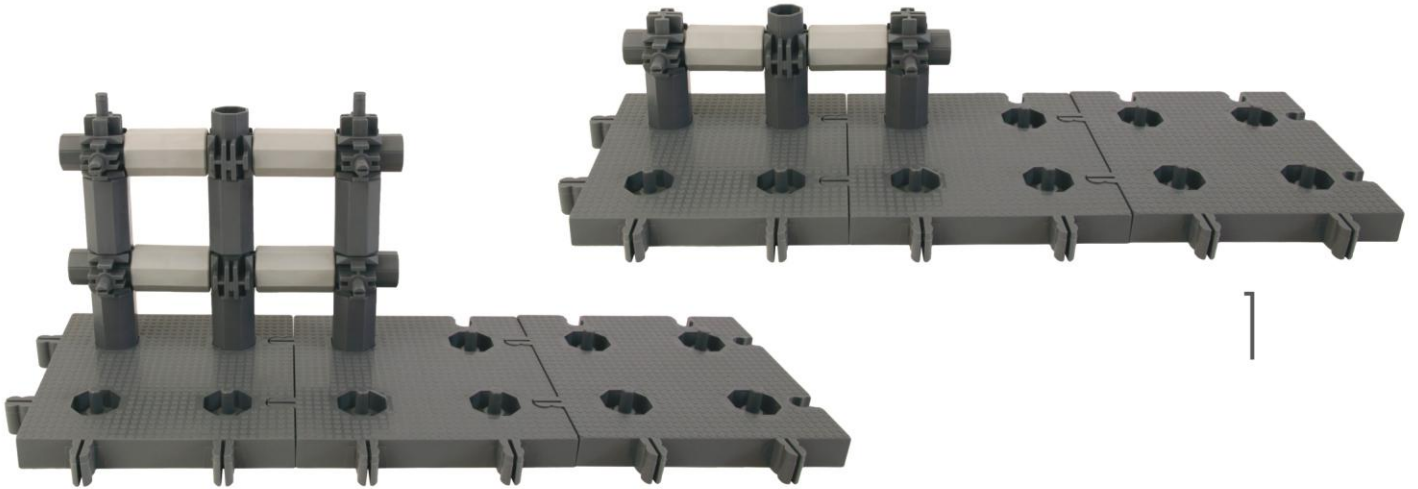

- 4 orange gears, 4 green gears, 3 grey gears, 1 black gear, 6 grey pins, 8 black pins, 3 black pins, 10 grey connectors, 2 grey L-shaped connectors, 3 grey plates, 2 yellow gears, 2 yellow propellers

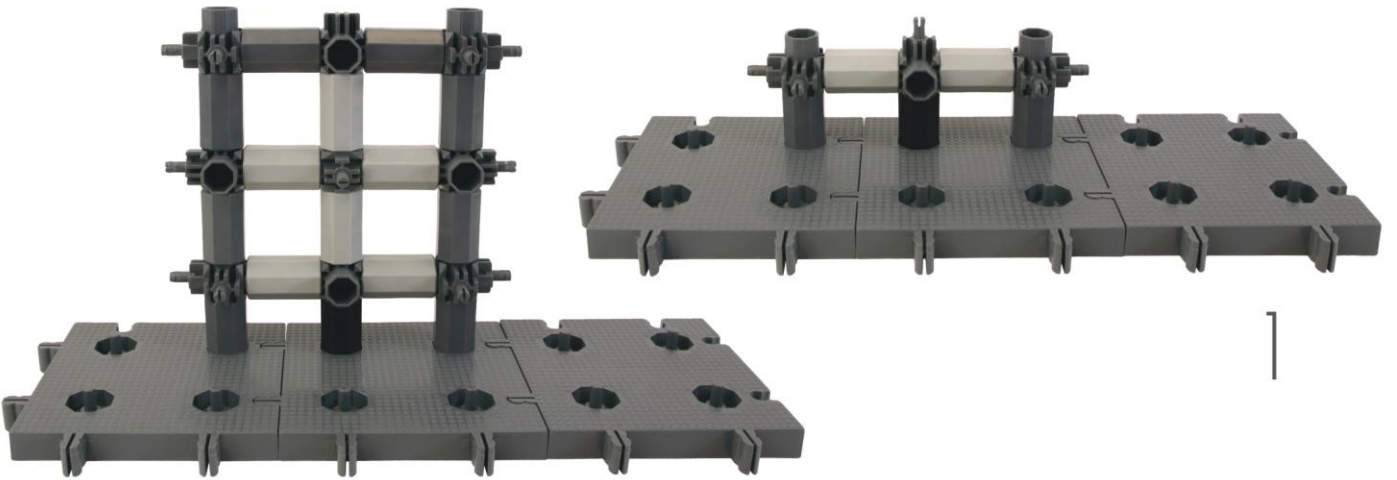

2

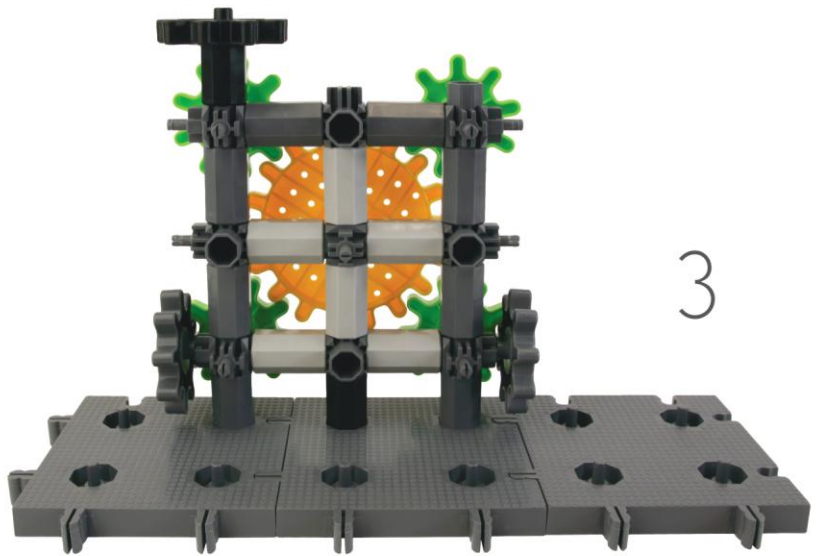

3

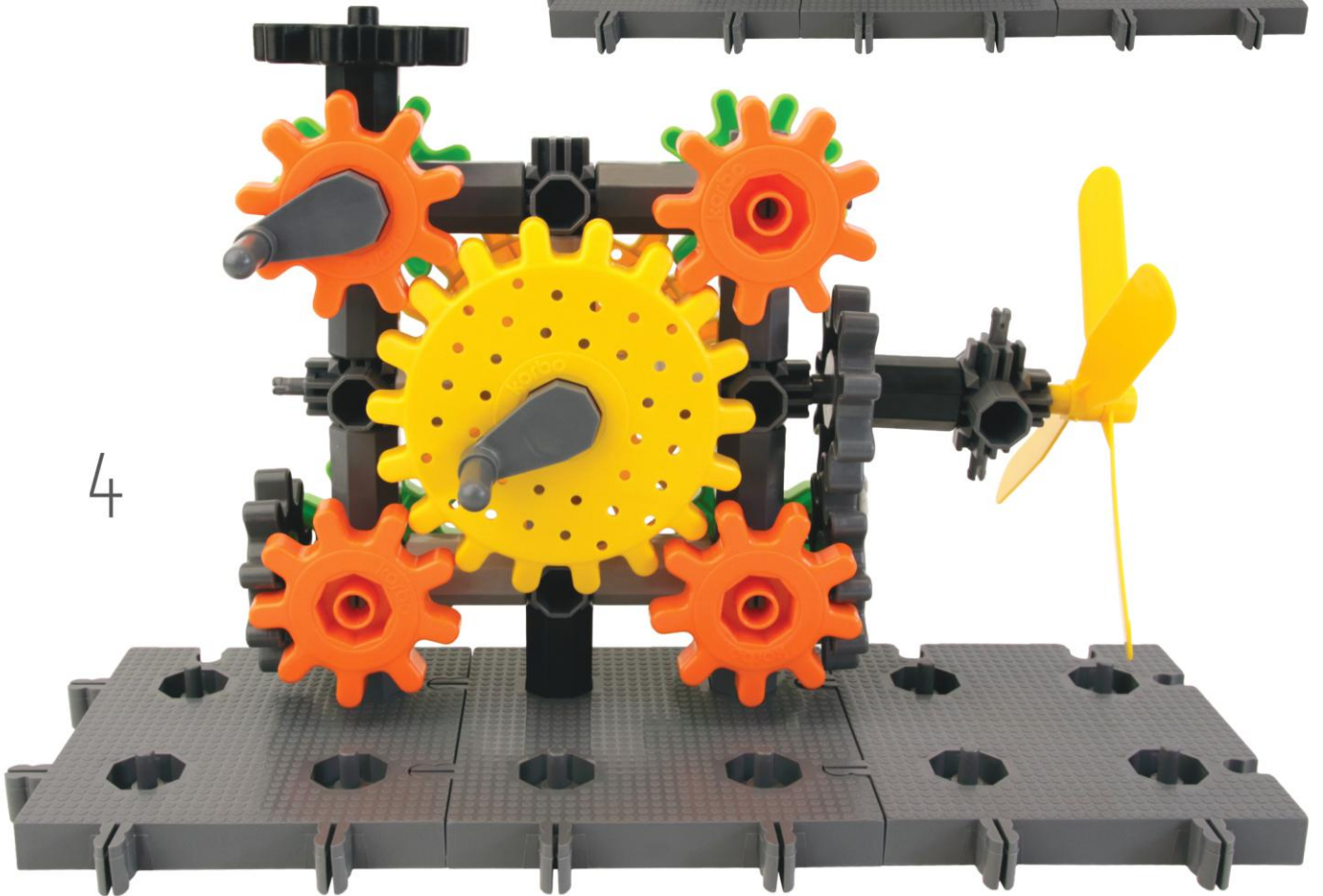

4

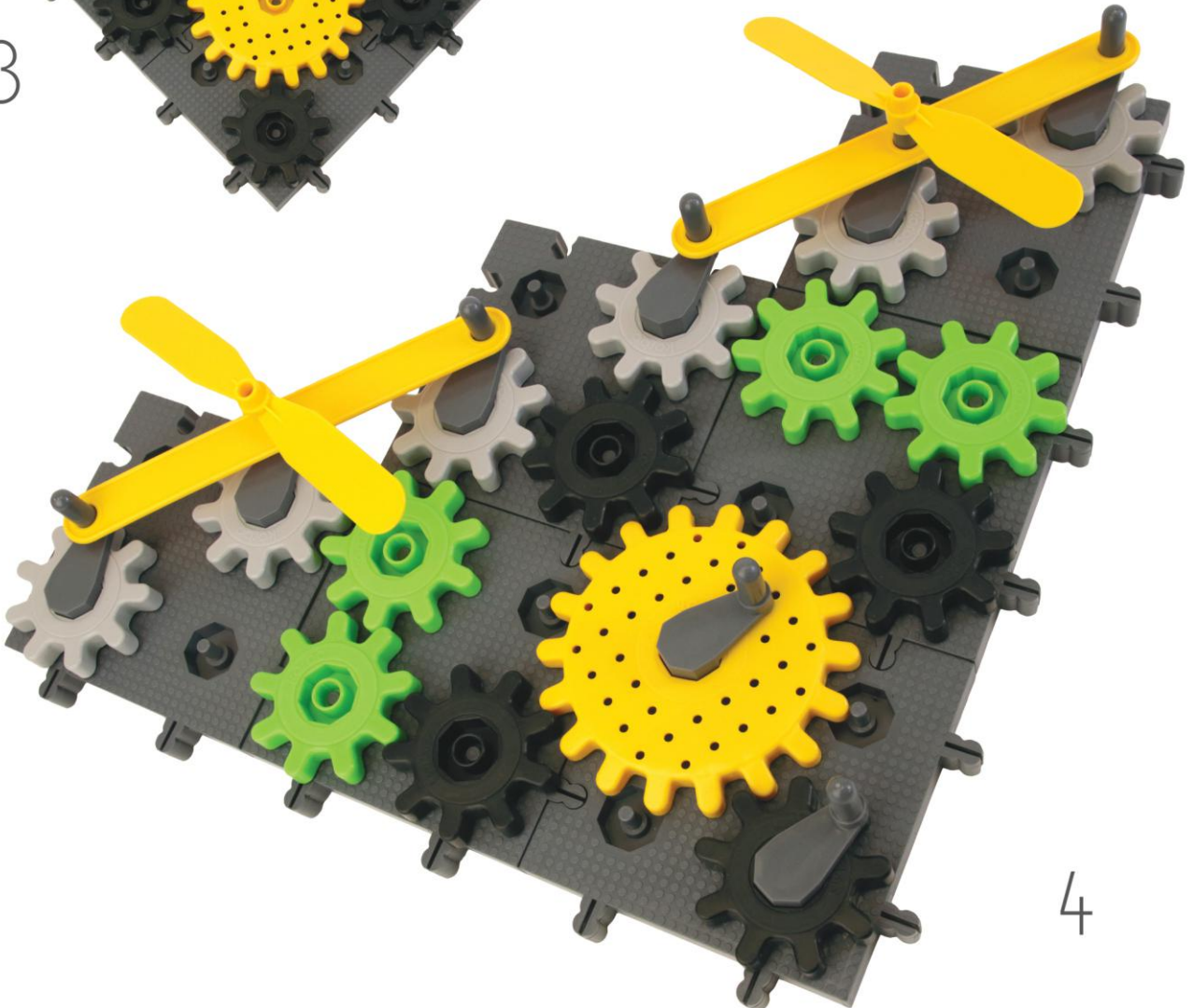
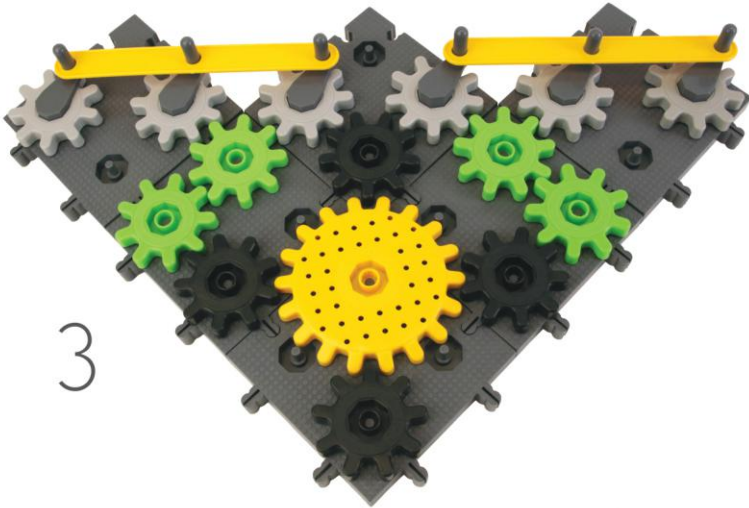
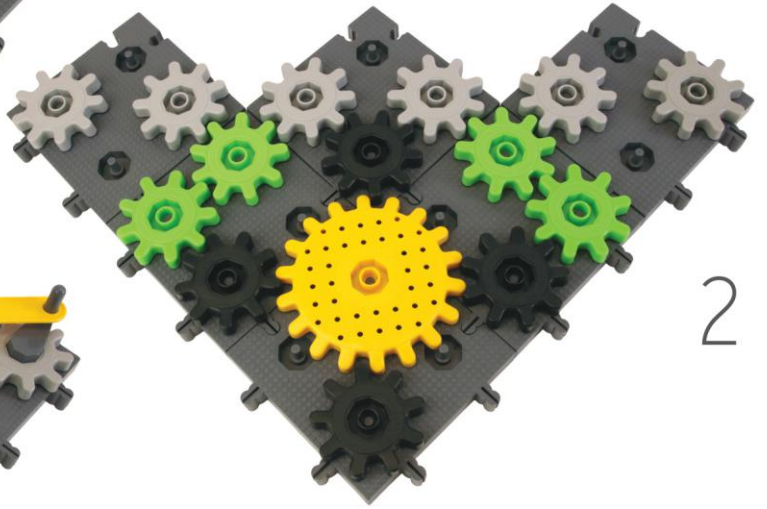
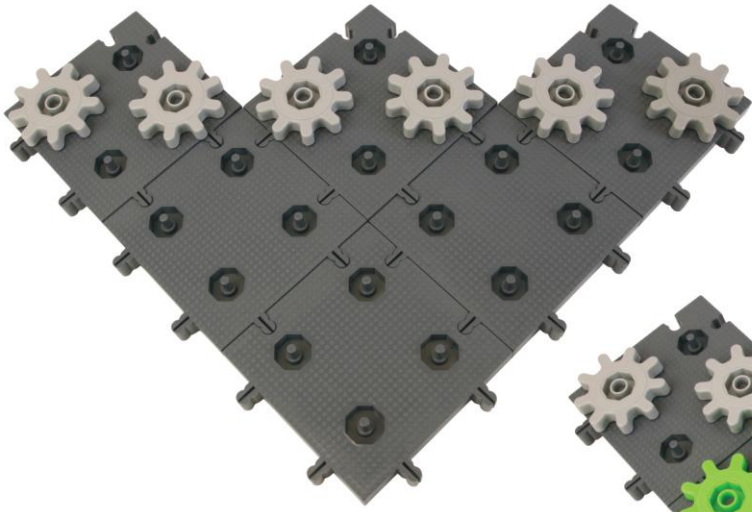

14 8 16 15 12 2 3 1

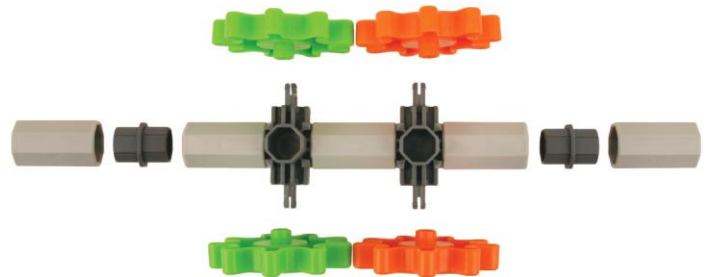
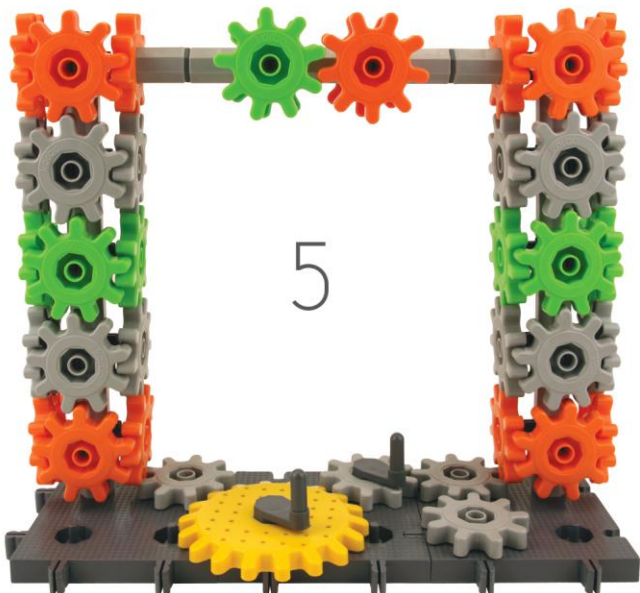
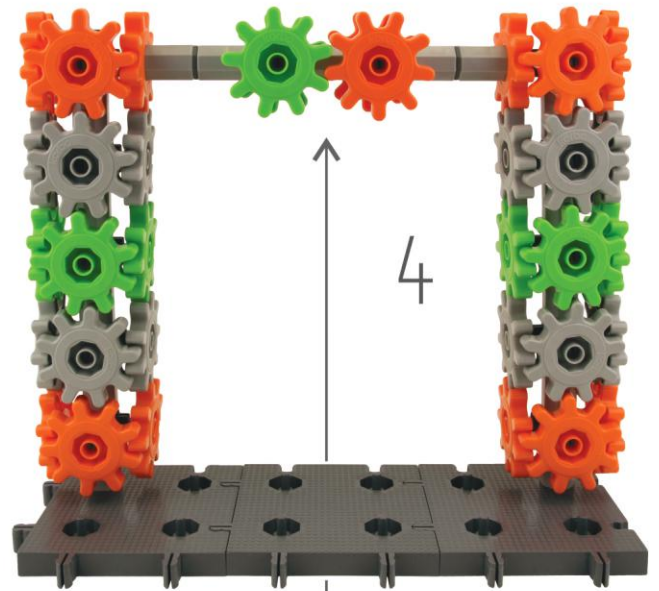
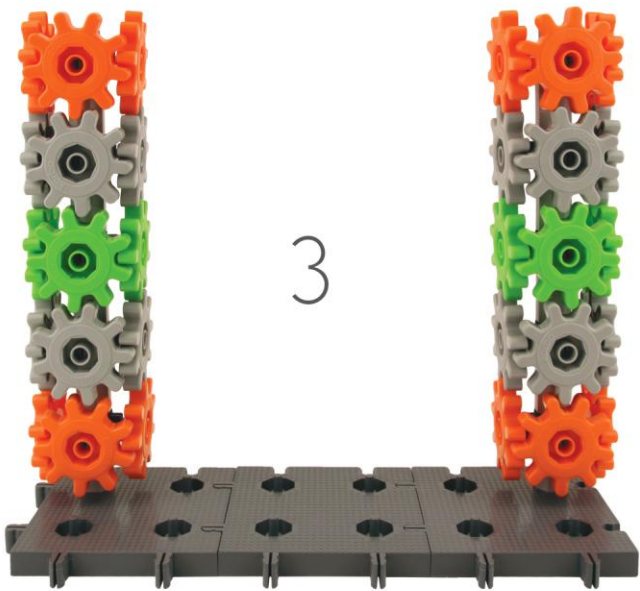
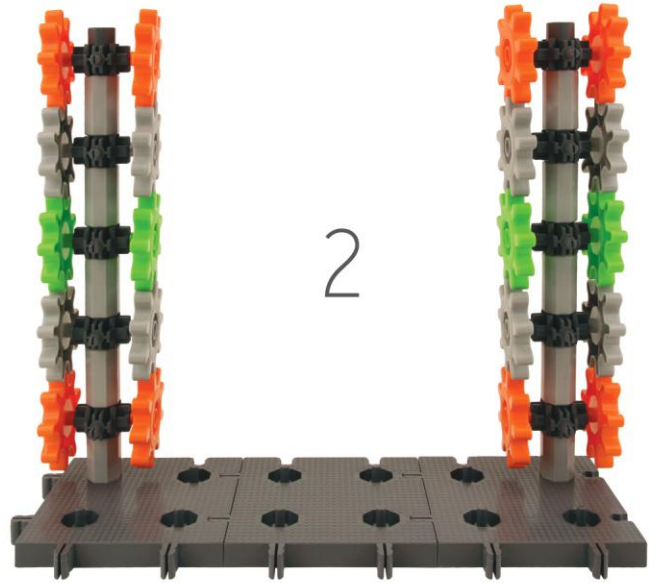
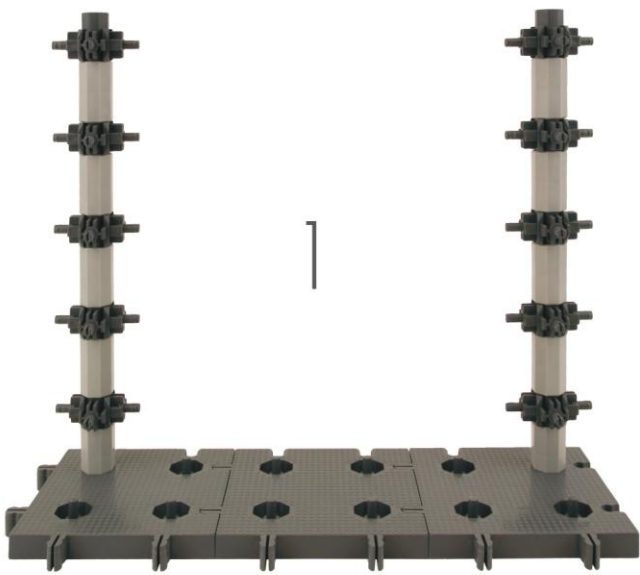

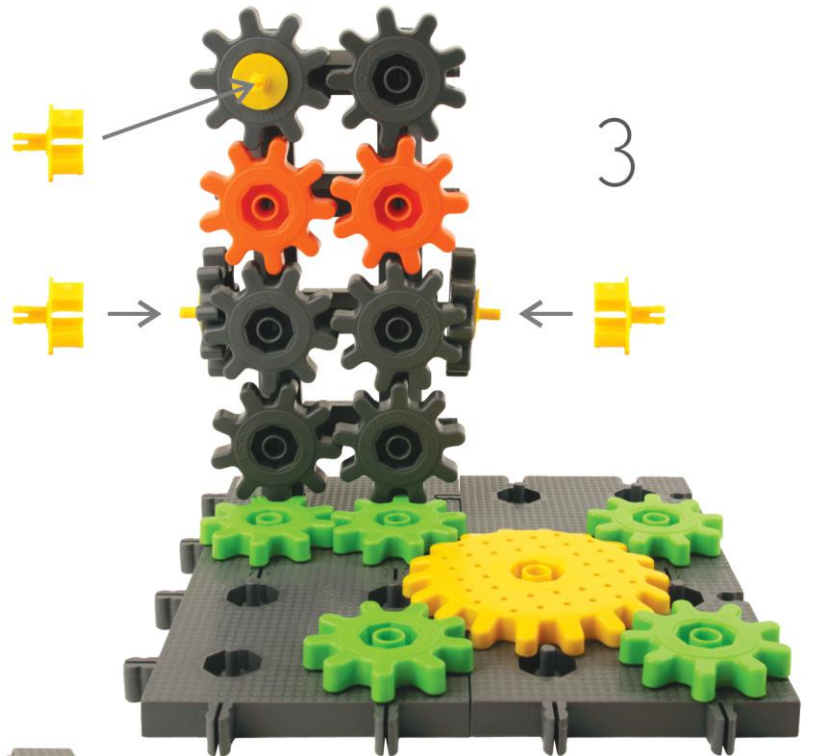
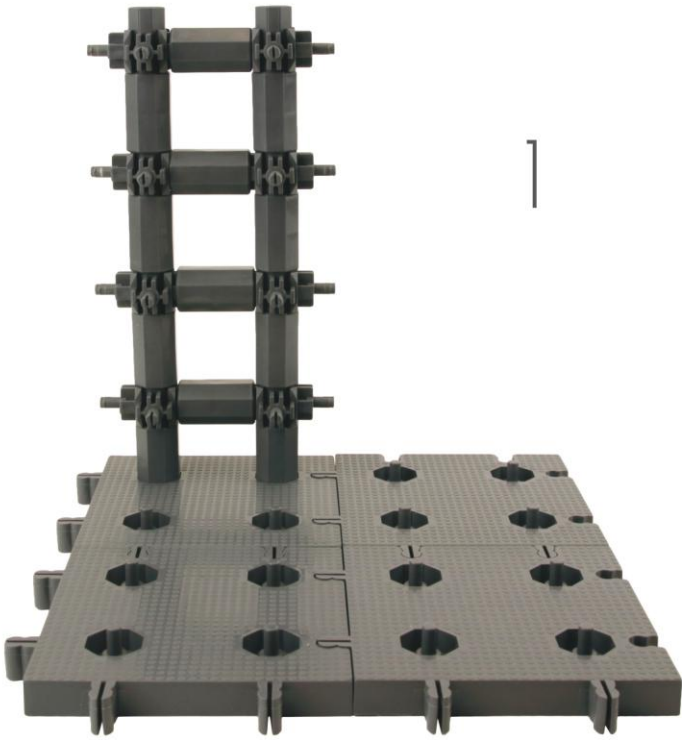

6 8 18 14 2 4 2 1 8 8

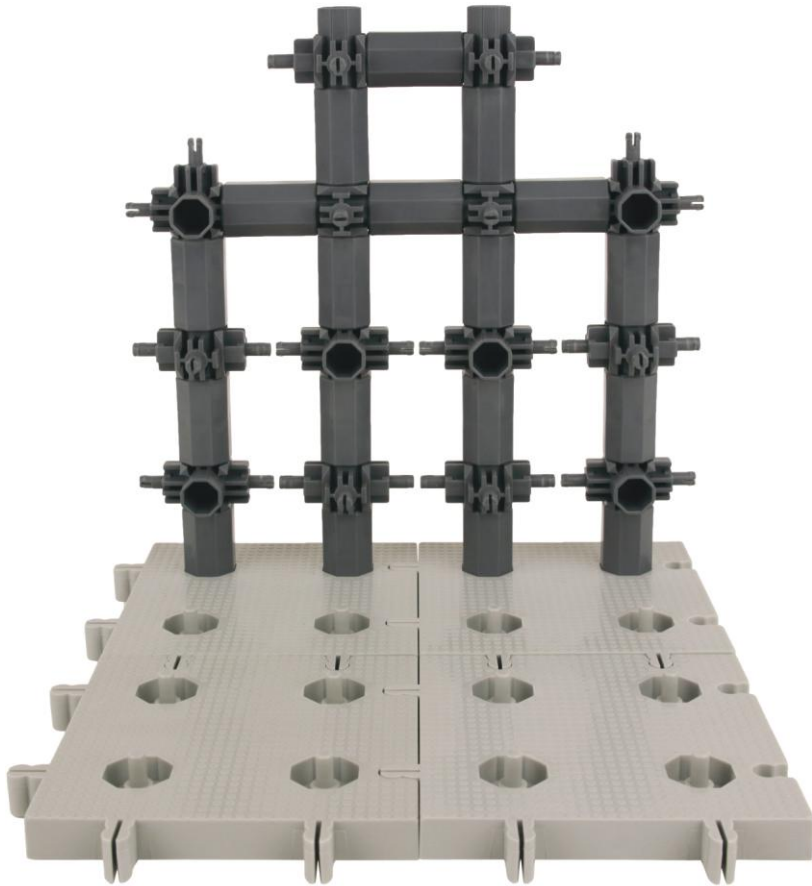

1



2

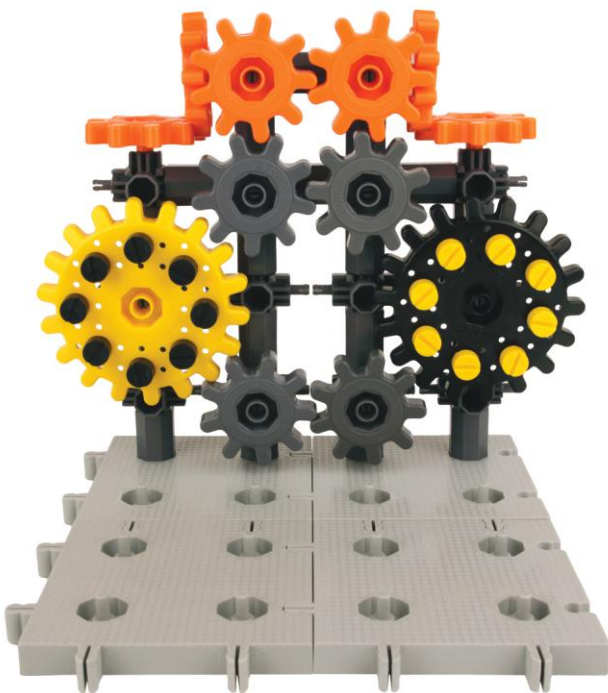



3

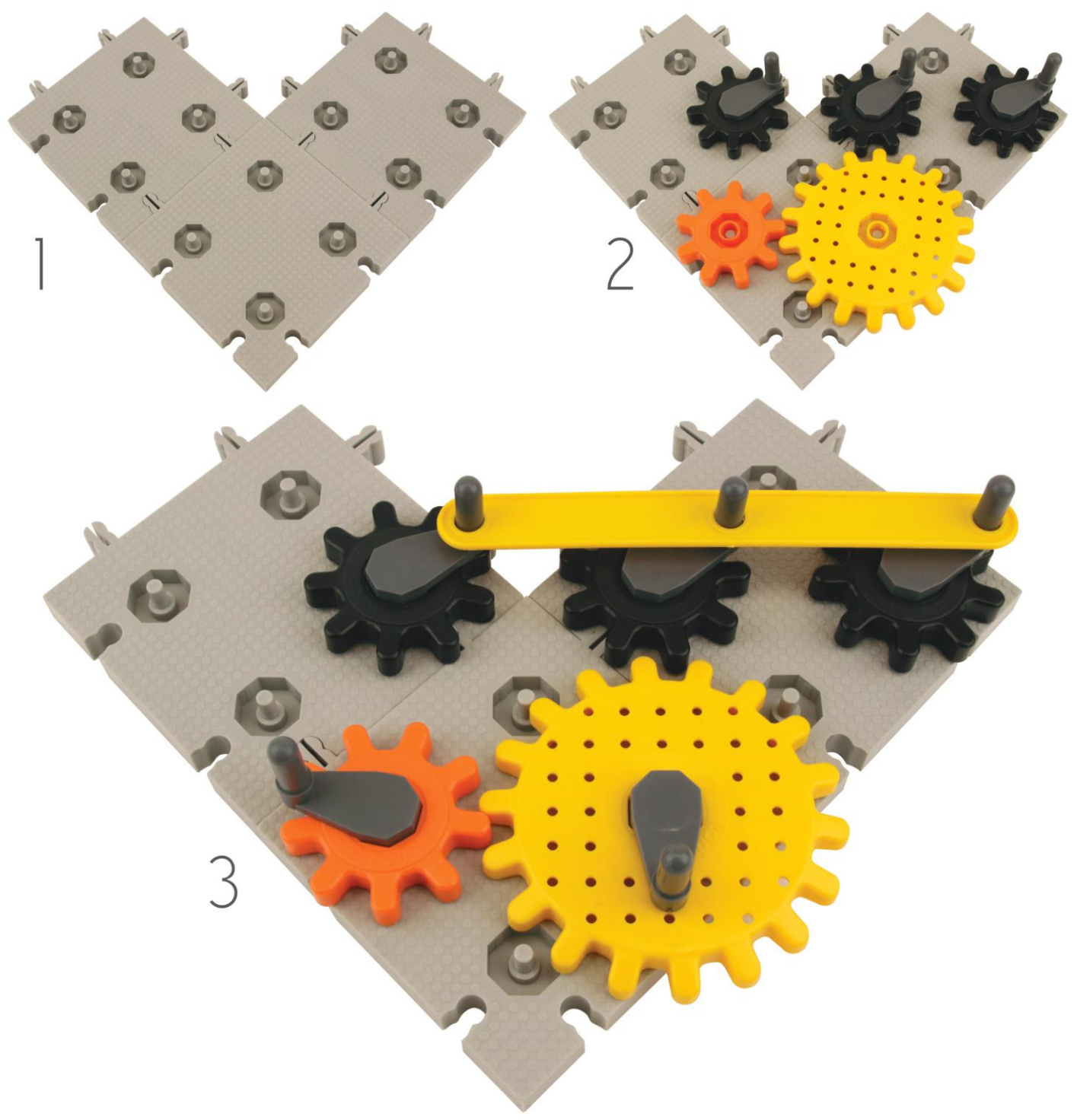

4



[PL] Jeżeli element B  trudno wchodzi do elementu A  lub F  włóż go odwrotną stroną.  
 [GB] Once you find it difficult to put the element B into elements A or F please insert it with the reverse side.  
 [DE] Wenn es ist schwer das Element B in die Elemente A oder F zu legen, legen Sie es bitte mit der Rückseite ein.  
 [RU] Если элемент B не входит в элементы A и F попробуйте вставить его обратной стороной.  
 [ES] Si tienes dificultad en entrar el elemento B al elemento A o F, te aconsejamos ponerlo del revés.

[PL] Koło z korbką to koło napędowe. Pamiętaj, lekkość kręcenia konstrukcji zależy, gdzie umiejscowisz korbkę.  
 [GB] The gear with the crank is the driving gear. Remember - spinning effort depends on where you place the crank.  
 [DE] Das Zahnrad mit der Kurbel ist das treibende Zahnrad. Denken Sie daran - die Spinnanstrengung hängt davon ab, wo Sie die Kurbel setzen.  
 [RU] Шестеренка с ручкой является ведущей. Помните – легкость вращения конструкции зависит от того где расположишь ручку.  
 [ES] La rueda con la manivela es la rueda de transmisión. Recuerda, el esfuerzo de giro para mover la construcción dependerá de dónde se coloque la manivela.

[PL] Każda konstrukcja mechaniczna przy wielokrotnych obrotach luzuje się. Podczas zabawy „serwisuj” swoje konstrukcje dociskając wszystkie elementy, aby poruszały się sprawnie.  
 [GB] Every mechanical construction gets loose after multiple spins. While playing "service" your constructions by tightening all elements together to make the move efficiently.  
 [DE] Jede mechanische Konstruktion löst sich nach mehreren Drehungen. Während des Spiels "Service" Ihre Konstruktionen durch Anziehen aller Elemente zusammen, um den Umzug effizient zu machen.  
 [RU] Каждая механическая конструкция при долгом вращении начинает терять свою прочность. Играя, «проводит техобслуживание» своего механизма. Периодически дожимайте элементы так чтобы конструкции правильно функционировали.  
 [ES] Cada construcción mecánica se suelta tras hacer múltiples giros. Mientras juegas con tu construcción mantén los elementos bien apretados para que se mueva de manera eficiente.