

korbo

EDU PASTEL

370 PIECES :: 4+ YEARS OLD

100 ways to spin, learn & play!

A		110x
B		90x
C		50x
D		60x
E		20x
F		20x
G		20x

NEW!

Various Korbo connections

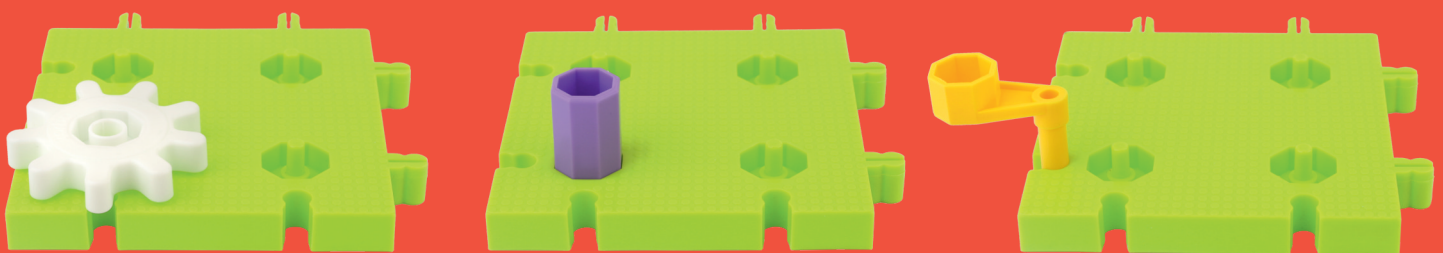
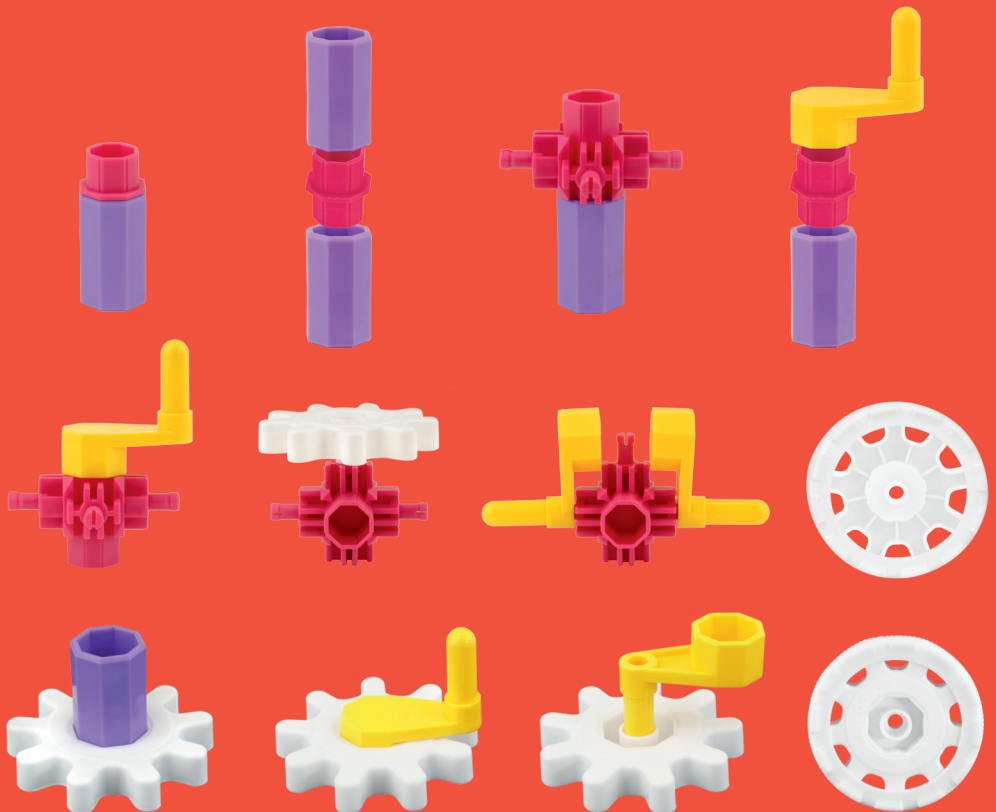

- PL Jeżeli element B trudno wchodzi do elementu A lub F włóż go odwrotną stroną.
- GB Once you find it difficult to put the element B into elements A or F please insert it with the reverse side.
- DE Wenn es ist schwer das Element B in die Elemente A oder F zu legen, legen Sie es bitte mit der Rückseite ein.
- RU Если элемент B не входит в элементы A и F попробуйте вставить его обратной стороной.
- ES Si tienes dificultad en entrar el elemento B al elemento A o F, te aconsejamos ponerlo del revés.

3 degrees of difficulty



- PL Koło z korbką to koło napędowe. Pamiętaj, lekkość kręcenia konstrukcji zależy, gdzie umiejscowisz korbkę.
- GB The gear with the crank is the driving gear. Remember - spinning effort depends on where you place the crank.
- DE Das Zahnrad mit der Kurbel ist das treibende Zahnrad. Denken Sie daran - die Spinnanstrengung hängt davon ab, wo Sie die Kurbel setzen.
- RU Шестеренка с ручкой является ведущей. Помните – легкость вращения конструкции зависит от того где расположишь ручку.
- ES La rueda con la manivela es la rueda de transmisión. Recuerda, el esfuerzo de giro para mover la construcción dependerá de dónde se coloque la manivela.

- PL Każda konstrukcja mechaniczna przy wielokrotnych obrotach luzuje się. Podczas zabawy „serwisuj” swoje konstrukcje dociskając wszystkie elementy, aby poruszały się sprawnie.
- GB Every mechanical construction gets loose after multiple spins. While playing "service" your constructions by tightening all elements together to make the move efficiently.
- DE Jede mechanische Konstruktion löst sich nach mehreren Drehungen. Während des Spiels "Service" Ihre Konstruktionen durch Anziehen aller Elemente zusammen, um den Umzug effizient zu machen.
- RU Каждая механическая конструкция при долгом вращении начинает терять свою прочность. Играя, «проводит техобслуживание» своего механизма. Периодически дожимайте элементы так чтобы конструкции правильно функционировали.
- ES Cada construcción mecánica se suelta tras hacer múltiples giros. Mientras juegas con tu construcción mantén los elementos bien apretados para que se mueva de manera eficiente.



REMI
04-445 Warszawa, Poland
ul. Szafarzy 71
tel. +48 22 858 16 55
www.korbo.eu

- PL Kolorystyka wszystkich konstrukcji jest przykładowa.
- GB Colour combinations of all constructions is only an example.
- DE Die abgebildeten Farbkombinationen der Figuren sind nur Beispiele.
- RU Расцветка всех конструкций случайная.
- NL De kleurencombinaties van alle constructies zijn bij wijze van voorbeeld.
- ES Los colores de todas las construcciones sirven de ejemplo.
- FR Les couleurs de toutes les constructions ce n'est qu'un exemple.

CRADLE



- 6x (Red gear)
- 6x (Green gear)
- 1x (White gear)
- 8x (Red pin)
- 7x (Purple pin)
- 7x (White pin)
- 9x (Red gear)
- 7x (Red gear)
- 4x (Yellow plate)
- 2x (Green plate)

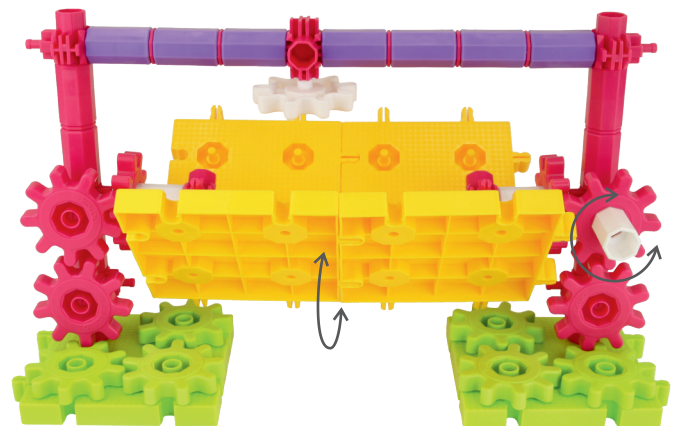
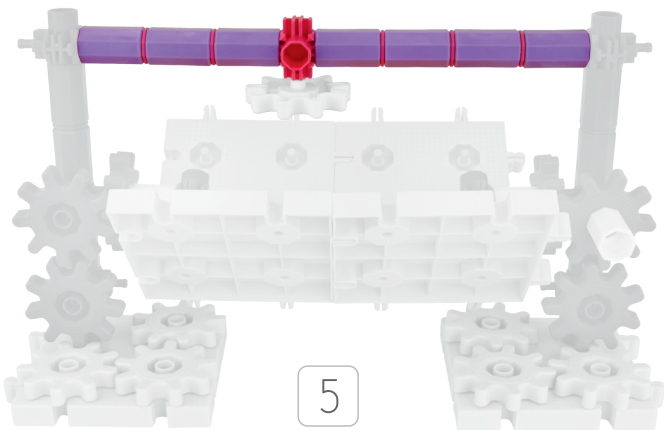
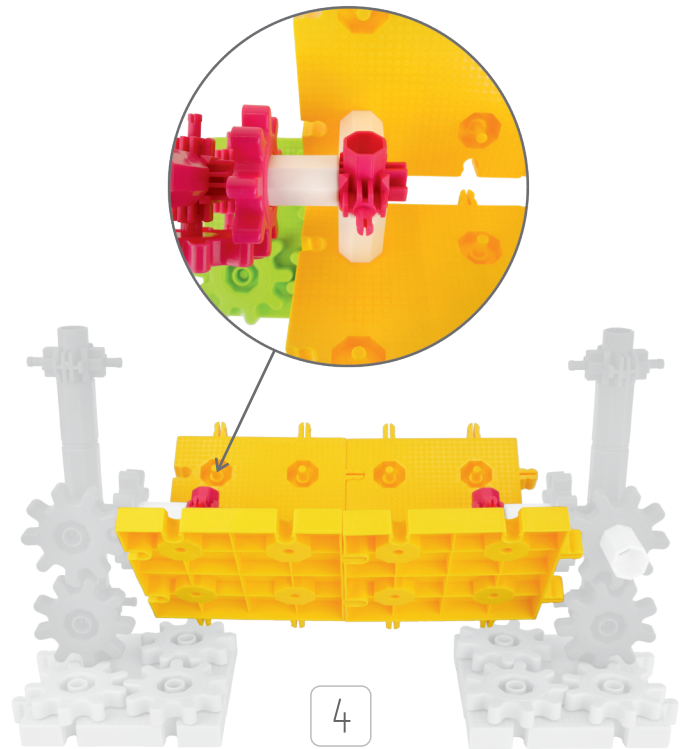
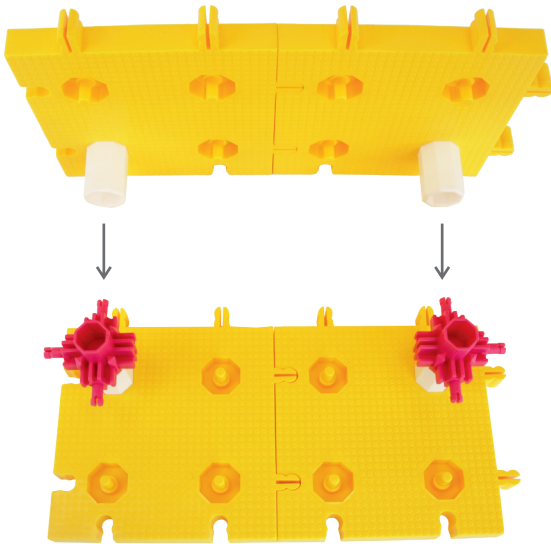
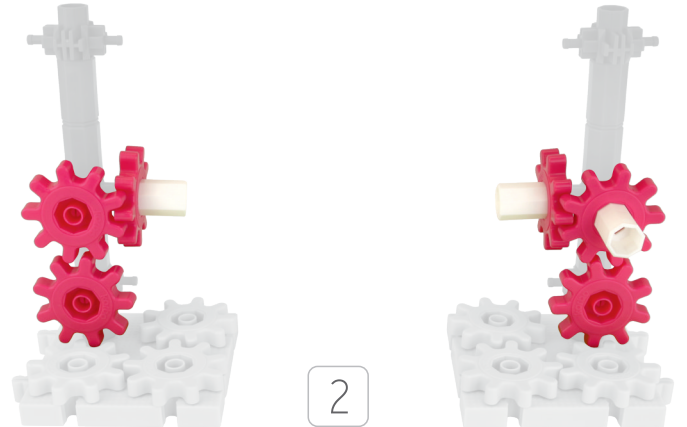
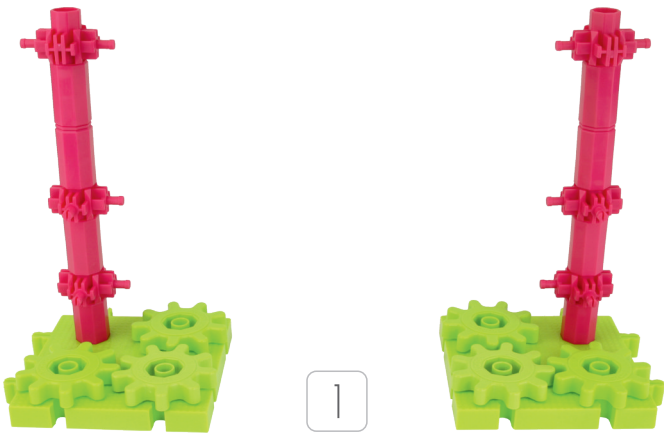

PRAM 1

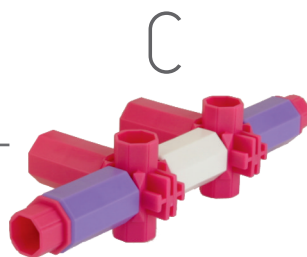
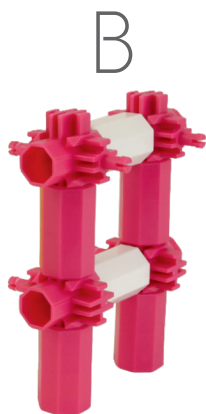
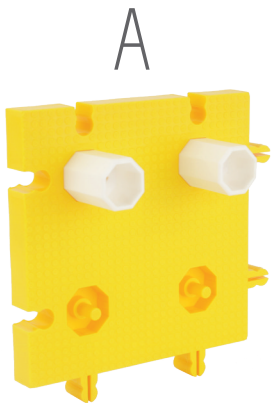
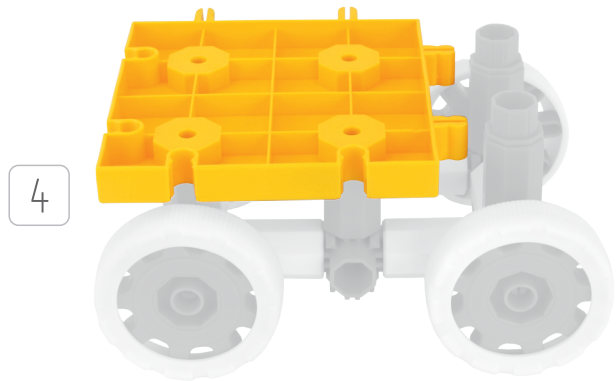
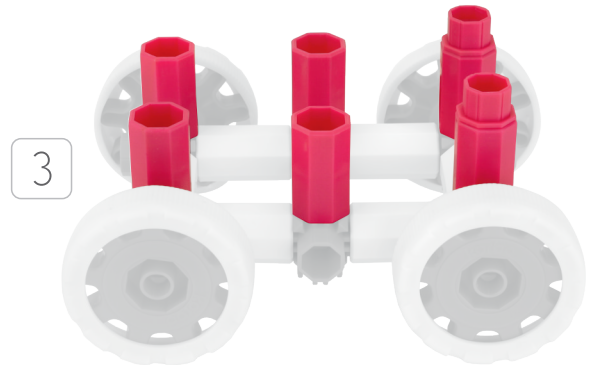
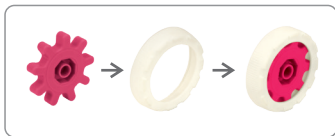
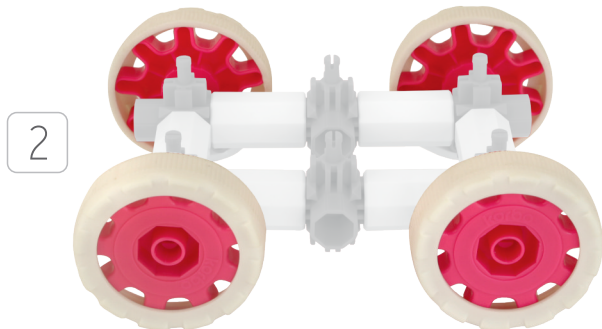
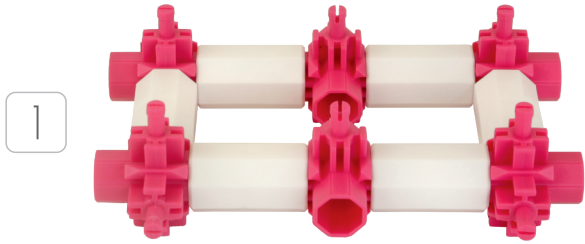

5

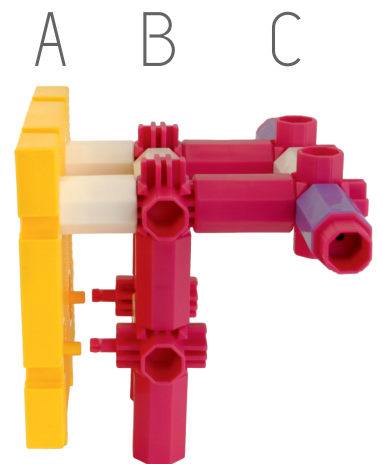

6

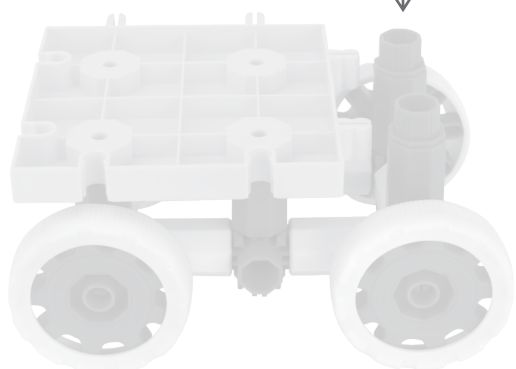

PRAM 2 / PRAM 3



PRAM 1

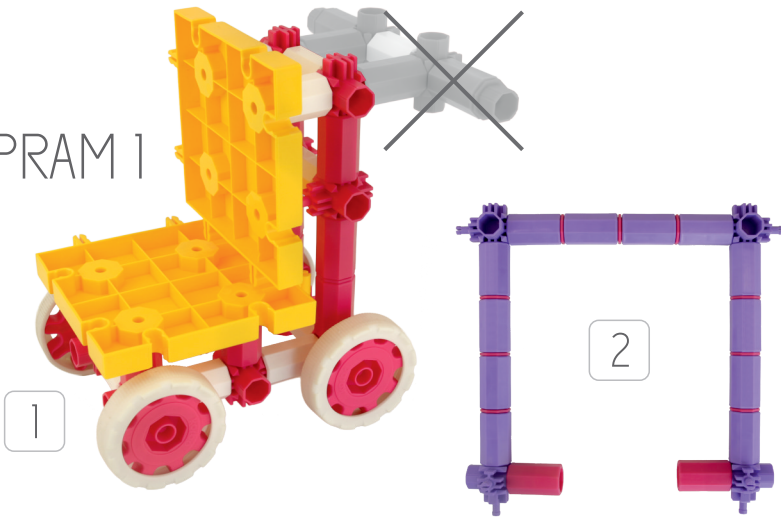

PRAM 2

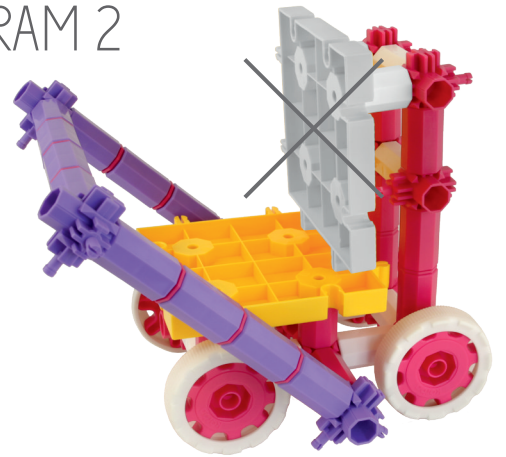

PRAM 2

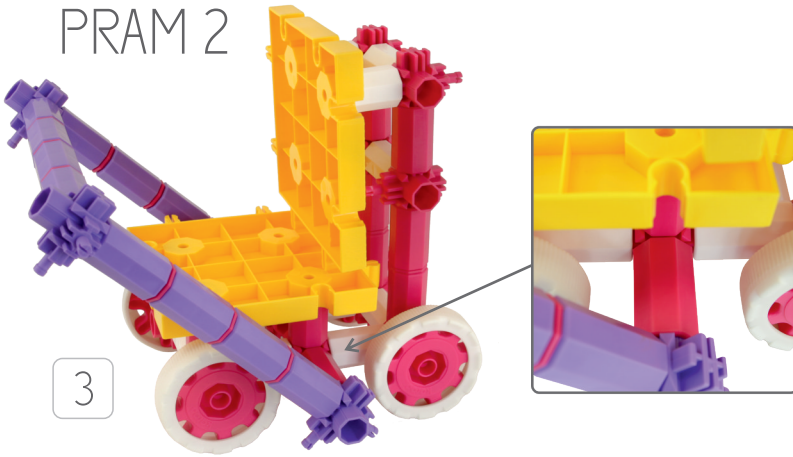

PRAM 3

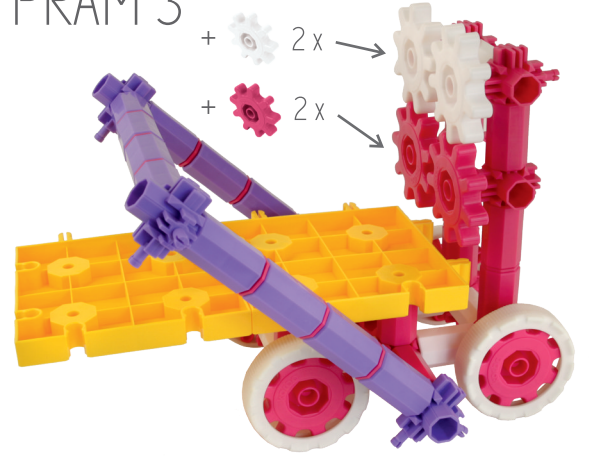

BIKE

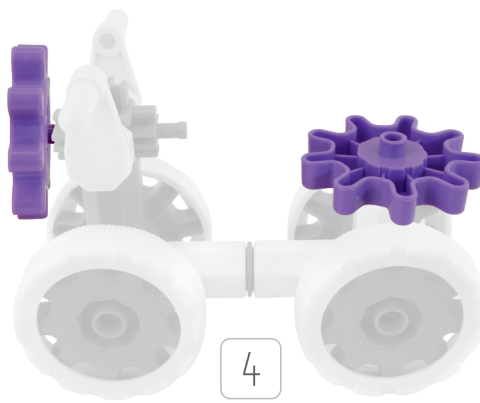
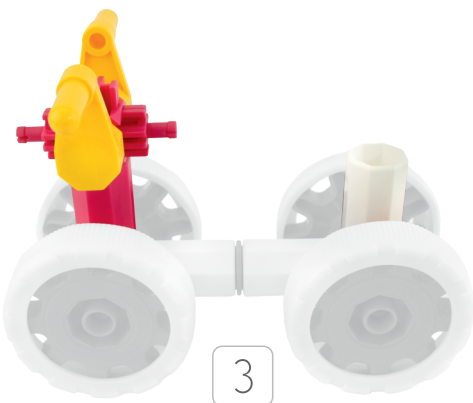
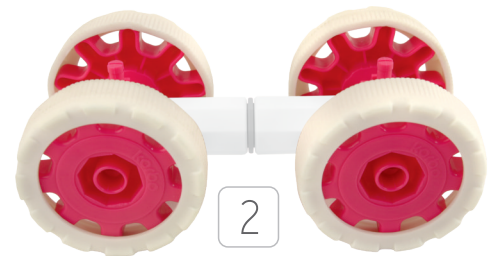
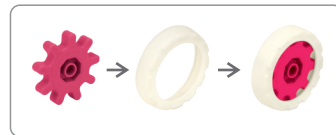
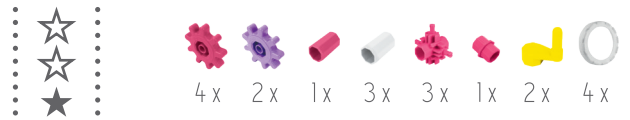

CAR

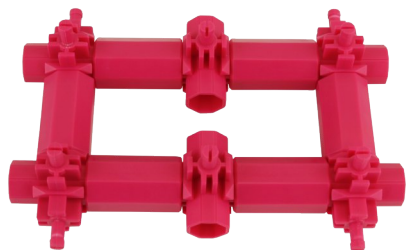

1



2

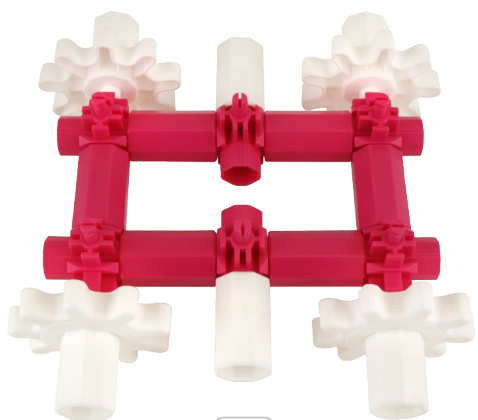

3

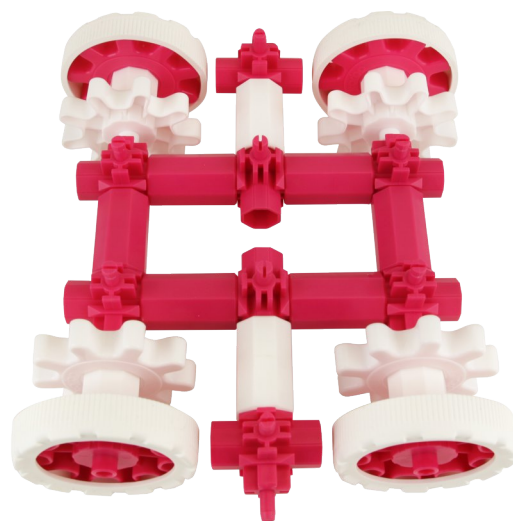
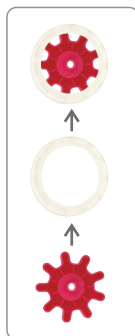

4



5



6

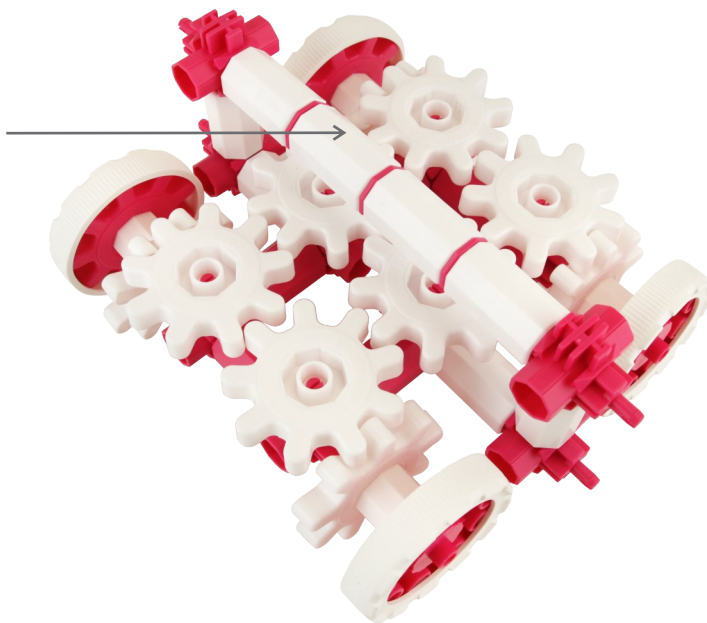

HOUSE

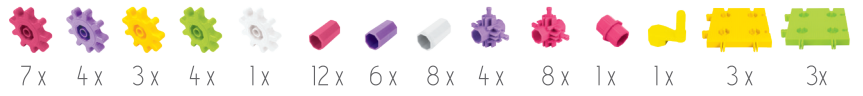

7x 4x 3x 4x 1x 12x 6x 8x 4x 8x 1x 1x 3x 3x

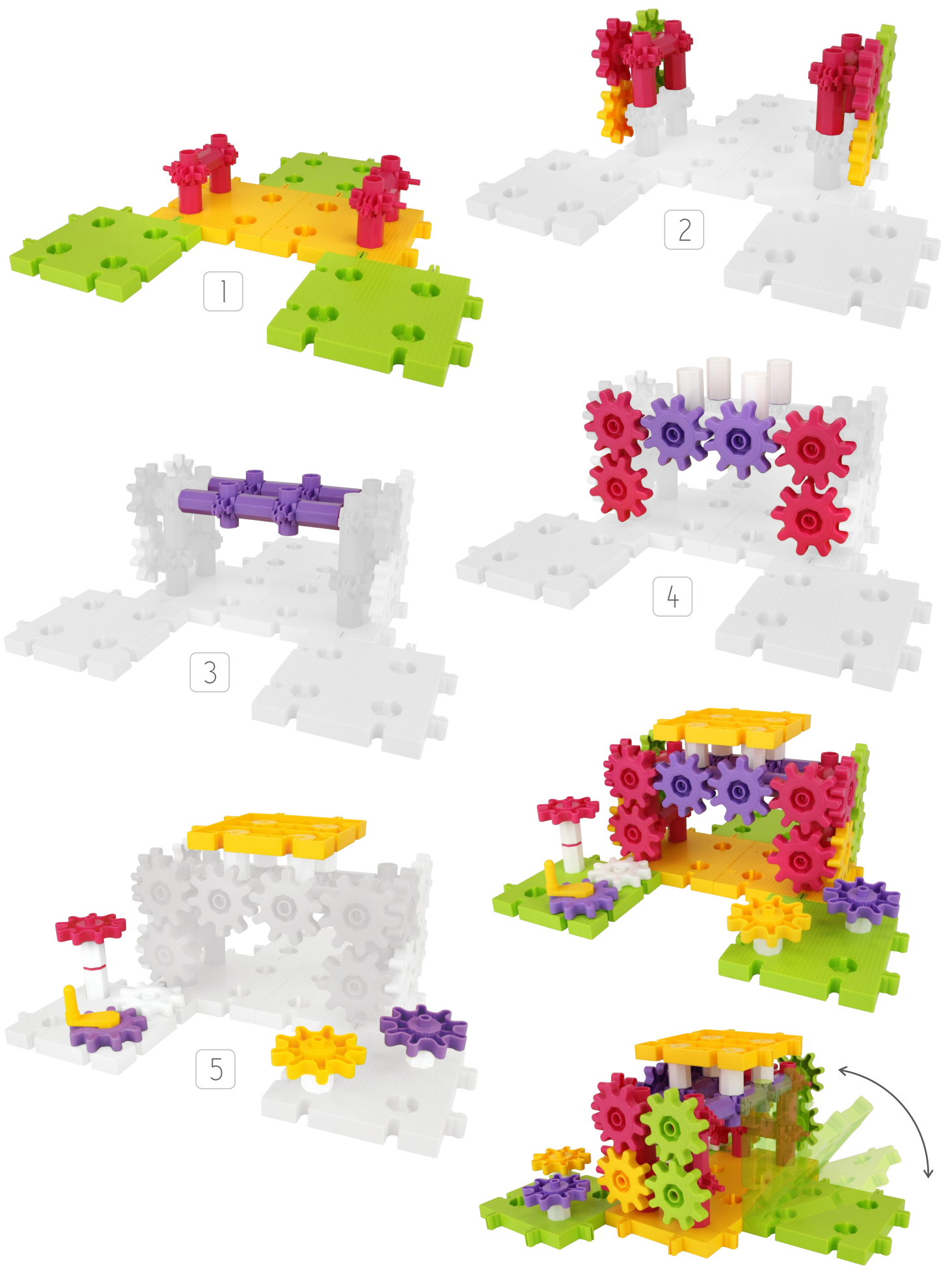

1

2

3

4

5